



# ***Owner's Manual***

**Original Instructions**   
Air Conditioners

Air-to-water Split Heat Pump

Thank you for choosing ALPICAIR air conditioners. Please read this Owner's Manual carefully before operation and retain it for future reference.

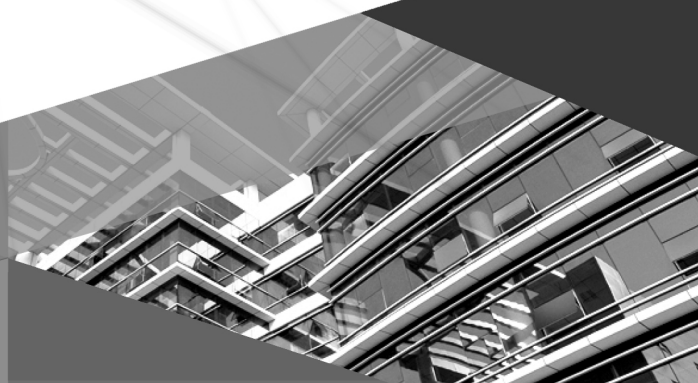

## To Users

Thank you for selecting our product. Please read this instruction manual carefully before installing and using the product, so as to master and correctly use the product. In order to guide you to correctly install and use our product and achieve expected operating effect, we hereby instruct as below:

- (1) This equipment should be installed, operated or maintained by the qualified servicemen who have had specific training. During operation, all safety issues covered in the labels, User's Manual and other literature should be followed strictly. This equipment is not intended for use by persons (including children) with reduced physical, sensory or mental capabilities, or lack of experience and knowledge, unless they have been given supervision or instruction concerning use of the appliance by a person responsible for their safety. Children should be supervised to ensure that they do not play with the appliance.
- (2) This product has gone through strict inspection and operational test before leaving the factory. In order to avoid damage due to improper disassembly and inspection, which may impact the normal operation of unit, please do not disassemble the unit by yourself. You can contact our designated dealer or local service center for professional support if necessary.
- (3) When the product is faulted and cannot be operated, please contact our designated dealer or local service center as soon as possible by providing the following information..
  - Contents of nameplate of product (model, cooling/heating capacity, product No., ex-factory date).
  - Malfunction status (specify the situations before and after the error occurs).
- (4) All the illustrations and information in the instruction manual are only for reference. In order to make the product better, we will continuously conduct improvement and innovation without further notice.

# Contents

<b>Safety Notices (Please be sure to abide )</b> .....	<b>1</b>
<b>1. Product Data</b> .....	<b>7</b>
1.1 Outline Dimensions .....	7
1.2 Operation Temperature Range .....	9
1.3 Sizes of Pipelines.....	9
1.4 Operation Modes .....	9
<b>2 General Introduction to the Controller</b> .....	<b>10</b>
2.1 Home Page .....	10
2.2 Menu Page.....	11
2.3 Backlight .....	12
<b>3 Operation Instructions to the Controller</b> .....	<b>13</b>
3.1 ON/OFF .....	13
3.2 Function Setting .....	13
3.2.1 Mode .....	14
3.2.2 Fast hot water.....	15
3.2.3 Cool + hot water .....	15
3.2.4 Heat + hot water .....	15
3.2.5 Quiet mode.....	16
3.2.6 Weather depend.....	16
3.2.7 Weekly timer.....	17
3.2.8 Holiday release.....	17
3.2.9 Disinfection.....	18
3.2.10 Clock timer .....	18
3.2.11 Temp. timer .....	20
3.2.12 Emergen. mode.....	20
3.2.13 Holiday mode .....	21
3.2.14 Preset mode .....	22
3.2.15 Error reset .....	22
3.2.16 Disinfection WiFi reset.....	23
3.2.17 Reset.....	23
3.2.18 Child lock.....	23
3.2.19 Daylight saving time .....	23
3.3 User Parameter Setting .....	24
3.4 Viewing .....	26

3.4.1 Status .....	27
3.4.2 Parameter.....	28
3.4.3 Error .....	29
3.4.4 Error log.....	30
3.4.5 Version .....	31
3.5 General Setting.....	31
3.5.1 Time and clock .....	31
<b>4. Troubleshooting and Maintenance .....</b>	<b>32</b>
4.1 Daily Operation and Maintenance.....	33
4.2 Notice before Seasonal Use .....	34
4.3 Error Codes.....	35

## Safety Notices (Please be sure to abide )

 **WARNING:** If not abide strictly, it may cause severe damage to the unit or the people.

 **NOTE:** If not abide strictly, it may cause slight or medium damage to the unit or the people.

 This sign indicates that the operation must be prohibited. Improper operation may cause severe damage or death to people

 This sign indicates that the items must be observed. Improper operation may cause damage to people or property.

### NOTE

After receipt of the unit, check it for appearance, unit model compared with your desire and attachments.

Design and installation work of the unit must be performed by authorized personnel according to applicable laws and regulations and this Instruction.

After installation work, the unit cannot be energized unless there is not any problem in check.

Ensure periodical clean and maintenance of the unit after normal operation of the unit for longer life and reliable operation.

If the supply cord is damaged, it must be replaced by the manufacturer, its service agent or similarly qualified persons in order to avoid a hazard.

The appliance shall be installed in accordance with national wiring regulations.







This product is a kind of comfort air conditioning, and is not allowed to be installed where there are corrosive, explosive and inflammable substances or smog; otherwise it would lead to operation failure, shortened service life, five hazard or even severe injuries. Special air conditions are required for where mentioned above.



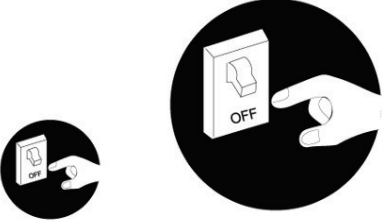



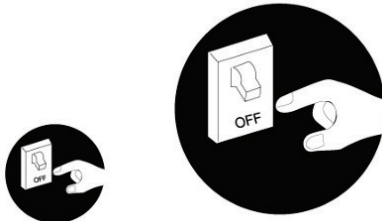

### Correct Disposure

This marking indicates that this product should not be disposed with other household wastes throughout the EU. To prevent possible harm to the environment or human health from uncontrolled waste disposal, recycle it responsibly to promote the sustainable reuse of material resources. To return your used device, please use the return and collection systems or contact the retailer where the product was purchased. They can take this product for environmental safe recycling.

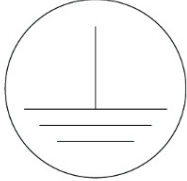
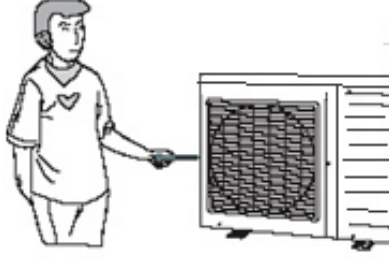
R32:675

<b>⚠ WARNING</b>		
<p>Once abnormality like burning smell occurs, please cut off the power supply immediately and then contact with service center.</p>  <p>If the abnormality still exists, the unit may be damaged and electric shock or fire may result.</p>	<p>Don't operate the unit with wet hand.</p>  <p>Otherwise, it may cause electric shock.</p>	<p>Before installation, please see if the voltage of local place accords with that on nameplate of unit and capacity of power supply, power cord or socket is suitable for input power of this unit.</p> 
<p>Special circuit must be adopted for power supply to prevent fire.</p>  <p>Do not use octopus multipurpose plug or mobile terminal board for wire connection.</p>	<p>Be sure to pull out the power plug and drain the indoor unit and water tank when unit is not in use for a long time.</p>  <p>Otherwise, the accumulated dust may cause overheating, fire or freeze of water tank or coaxial heater exchanger in winter.</p>	<p>Never damage the electric wire or use the one which is not specified.</p>  <p>Otherwise, it may cause overheating or fire.</p>

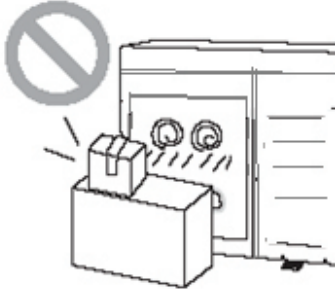
<p>Before cleaning please cut off the power supply.</p>   <p>Otherwise, it may cause electric shock or damage.</p>	<p>The power supply must adopt special circuit with leakage switch and enough capacity.</p>	<p>User can not change power cord socket without prior consent. Wiring working must be done by professionals. Ensure good earthing and don't change earthing mode of unit.</p>
<p>Earthing: the unit must be earthed reliably ! The earthing wire should connect with special device of buildings.</p>   <p>If not, please ask the qualified personnel to install. Furthermore, don't connect earth wire to gas pipe, water pipe, drainage pipe or any other improper places which professional does not recognize.</p>	<p>Never insert any foreign matter into outdoor unit to avoid damage . And never insert your hands into the air outlet of outdoor unit.</p> 	<p>Don't attempt to repair the unit by yourself.</p>  <p>Improper repair may cause electric shock or fire, so you should contact the service center to repair.</p>

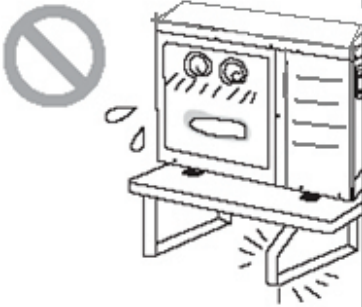
<p>Don't step on the top of the unit or place anything on it.</p>  <p>There is the danger of fall of things or people.</p>	<p>Never block the air inlet and outlet of unit.</p>  <p>It may reduce efficiency or cause stop of the unit and even fire.</p>	<p>Keep pressurized spray, gas holder and so on away from the unit above 1m .</p>  <p>It may cause fire or explosion.</p>
<p>Please note whether the installation stand is firm enough or not.</p>  <p>If damaged, it may cause fall of the unit and injury of people.</p>	<p>Unit should be installed at the place with good ventilation to save energy.</p>	<p>When there is not water in water tank, never power the unit on to run.</p>



**⚠ WARNING**

Do not use means to accelerate the defrosting process or to clean, other than those recommended by the manufacturer. Should repair be necessary, contact your nearest authorized service centre. Any repairs carried out by unqualified personnel may be dangerous. The appliance shall be stored in a room without continuous operating ignition sources. (for example: open flames, an operating gas appliance or an operating electric heater.) Do not pierce or burn.

Appliance shall be installed, operated and stored in a room with a floor area larger than  $Xm$  .(Please refer to table “a” in section of “ Safety Operation of Inflammable Refrigerant” for space X.)

Appliance filled with flammable gas R32. For repairs, strictly follow manufacturer’s instructions only. Be aware that refrigerants not contain odour. Read specialist’s manual.

If a stationary appliance is not fitted with a supply cord and a plug, or with other means for disconnection from the supply mains having a contact separation in all poles that provides full disconnection under overvoltage category III conditions, the instructions shall state that means for disconnection must be incorporated in the fixed wiring in accordance with the wiring rules.





This appliance can be used by children aged from 8 years and above and persons with reduced physical, sensory or mental capabilities or lack of experience and knowledge if they have been given supervision or instruction concerning use of the appliance in a safe way and understand the hazards involved. Children shall not play with the appliance. Cleaning and user maintenance shall not be made by children without supervision.

The appliance shall be stored in a well-ventilated area where the room size corresponds to the room area as specified for operation.

The appliance shall be stored in a room without continuously operating open flames (for example an operating gas appliance) and ignition sources (for example an operating electric heater).

The appliance shall be stored so as to prevent mechanical damage from occurring.

**⚠ NOTE**

	Appliance filled with flammable gas R32.
	Before use the appliance, read the owner’s manual first.
	Before install the appliance, read the installation manual first.
	Before repair the appliance, read the service manual first.

To realize the function of the air conditioner unit, a special refrigerant circulates in the system. The used refrigerant is the fluoride R32, which is specially cleaned. The refrigerant is flammable and inodorous. Furthermore, it can lead to explosion under certain conditions. But the flammability of the refrigerant is very low. It can be ignited only by fire.

Compared to common refrigerants, R32 is a nonpolluting refrigerant with no harm to the ozone layer. The influence upon the greenhouse effect is also lower. R32 has got very good thermodynamic features which lead to a really high energy efficiency. The units therefore need a less filling.

Before installation, please check if the adopted power is accordance with that listed on nameplate, and check the safety of power.

The unit shall contact with the supply mains by a full disconnection device under overvoltage category III .

Before using, please check and confirm if wires and water pipes are connected correctly to avoid water leakage, electric shock or fire etc.

Don't operate the unit with wet hand, and don't allow children to operate the unit.

The On/off in the instruction is for the operation to on and off button of PCB for users; cut off power means to stop supplying power to the unit.

Don't directly expose the unit under the corrosive ambient with water or dampness.

Don't operate the unit without water in water tank .The air outlet/inlet of unit cannot be blocked by other objects.

Never press the button with sharp objects to protect manual controller. Never use other wires instead of special communication line of the unit to protect control elements. Never clean the manual controller with benzene, thinner or chemical cloth to avoid fading of surface and failure of elements. Clean the unit with the cloth soaked in neutral eradicant. Slightly clean the display screen and connecting parts to avoid fading.

The power cord must be separated with the communication line.

Any person who is involved with working on or breaking into a refrigerant circuit should hold a current valid certificate from an industry-accredited assessment authority, which authorises their competence to handle refrigerants safely in accordance with an industry recognised assessment specification.

Servicing shall only be performed as recommended by the equipment manufacturer. Maintenance and repair requiring the assistance of other skilled personnel shall be carried out under the supervision of the person competent in the use of flammable refrigerants.

The range of external static pressures at which the appliance was tested (add-on heat pumps, and appliances with supplementary heaters, only); If the supply cord is damaged, it must be replaced by the manufacturer, its service agent or similarly qualified persons in order to avoid a hazard.

The appliance is intended to be permanently connected to the water mains and connected by a hose-set.

If there is any question, please contact with local dealer, authorized service center, agencies or our company directly.

# 1. Product Data

## 1.1 Outline Dimensions

(1) Outline Dimensions of Outdoor Units

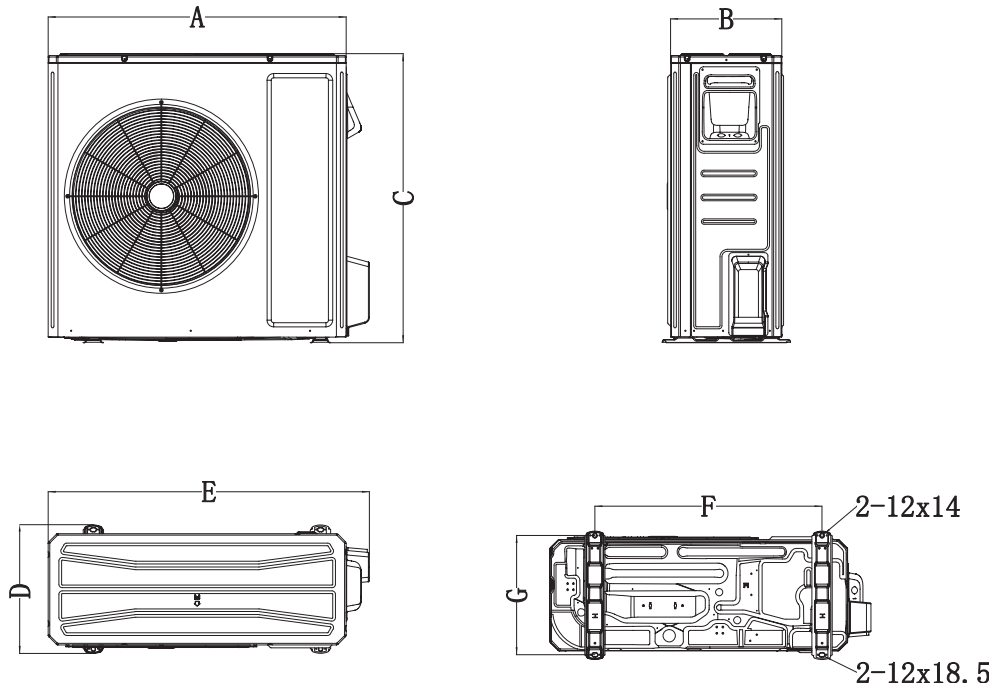

Outline Dimensions of the Outdoor Unit with a Single Fan

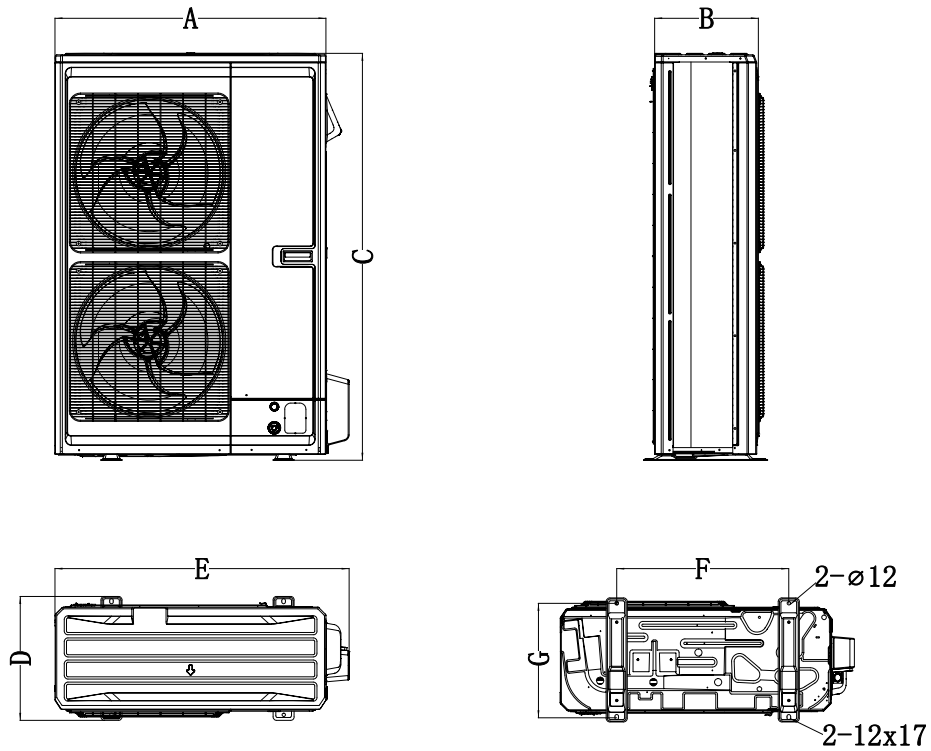

Outline Dimensions of Outdoor Unit with Double Fans

Model	A	B	C	D	E	F	G
4/6kW	924	385	746	427	1000	610	397
8/10/12/14kW	993	385	960	427	1067	755	397
12/14/16kW(dual-fan)	900	345	1352	412	977	572	378

(2) Outline Dimensions of Indoor Units

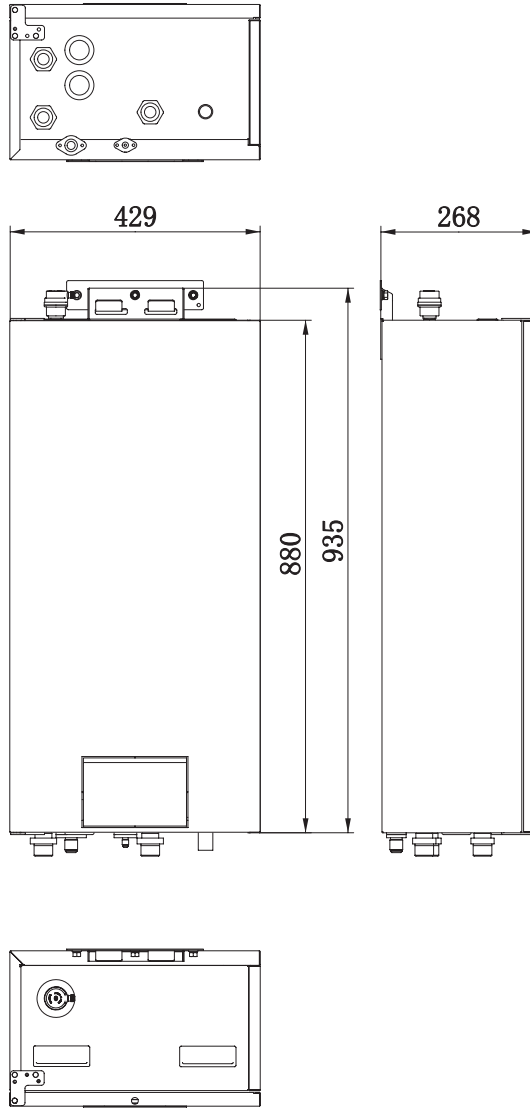

## 1.2 Operation Temperature Range

Mode	Heat Source Side Temperature (°C)	User Side Temperature (°C)
Heating	-30~35	20~65
Cooling	-15~48	5~25
Water Heating	-30~45	40~80

## 1.3 Sizes of Pipelines

No.	Name	Size	Model
1	Leaving Water Pipe	G1	/
2	Returning Water Pipe	G1	/
3	Gas-side Pipe	1/2	mode 4, mode 6
4		5/8	mode 8, mode 10 , mode 12, mode 14 mode 12, mode 14 mode 16
5	Liquid-side Pipe	1/4	mode 4, mode 6
6		3/8	mode 8, mode 10, mode 12, mode 14 mode 12, mode 14 mode 16

## 1.4 Operation Modes

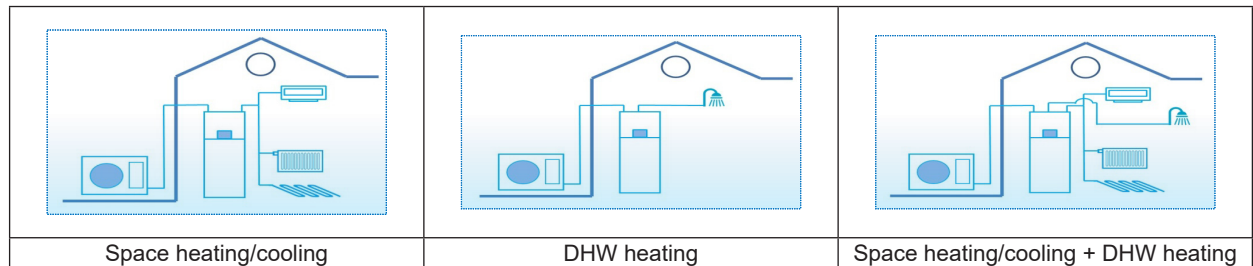

There are five basic working modes, including space cooling, space heating, domestic water heating, space cooling plus domestic water heating, and space heating plus domestic water heating.

- (1) **Spacing cooling:** it's used to reduce indoor temperature when ambient temperature is quiet high so as to make occupants in comfort.
- (2) **Space heating:** it's used to raise indoor temperature when ambient temperature is quiet low so as to make occupants in comfort.
- (3) **Domestic water heating:** it's used to provide domestic hot water in daily life for the user.
- (4) **Space cooling plus domestic water heating:** it is used to not only reduce indoor temperature but also provide domestic hot water.
- (5) **Space heating plus domestic water heating:** it is used to not only raise indoor temperature but also provide domestic hot water.

These five basic working modes can meet almost daily life requirements of air conditioning and domestic water hot for users.

## 2 General Introduction to the Controller



(This picture is just for reference)

This display panel uses the capacitor touch screen for input operation. The valid touching area indicates the black rectangle when the control panel lights off.

This control panel is of high sensitivity and will respond to unexpected click by the foreign matters on the display panel. Therefore, please keep it clean during operation.

This is a generous-purpose control panel, whose control functions might not be completely the same as those of the actually purchased. As the control program will update, the actual always prevails.

### 2.1 Home Page



Icon	Description	Icon	Description
	Space heating		Outdoor temperature
	Space cooling		Leaving water temperature of the main unit, leaving water temperature of the auxiliary electric heater, remote room temperature, water tank temperature
	Water heating		Error
	Menu		Card out/Failed disinfection
	Switchover between cooling and heating		ON/OFF
	Child lock		The main unit keeps the standby status under the SG control command.
	Weather depend		Holiday mode

[Notes]





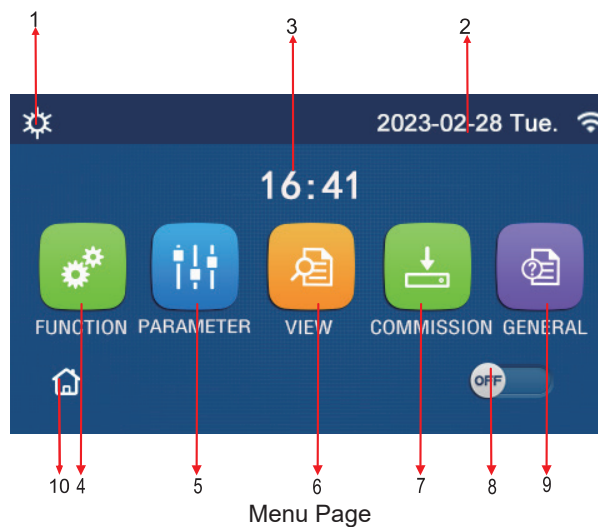

















- The ON/OFF icon will turn to green when the control panel is turned on.
- Under the “**Water heating**” mode, what displayed at the upper corner of the control panel is the water temperature of the water tank. Under the “**Space heating**” or “**Space cooling**” mode, what displayed depends on the setting of the control mode, that is, it will be the room temperature or leaving water temperature.
- Under the combined mode, the temperature set point is for space heating or cooling. Only under the water heating mode, it is for water heating.
- Homepage will always be activated after 10 minutes without user input.

## 2.2 Menu Page



Above the menu, the corresponding icon will be displayed based on the mode and status of the control panel.

No.	Item	Description
1	Control mode	Current mode
2	Date	Current date
3	Time	Current time
4	FUNCTION	Go to the user setting page.
5	PARAMETER	Go to the parameter setting page.
6	VIEW	Go to the parameter viewing page.
7	COMMISSIONING	Go to the commissioning parameter setting page. If you need to modify them, please contact the equipment manufacturer.
8	ON/OFF	It is used to turn on or off the control panel. “ <b>OFF</b> ” indicates the control panel has been turned off and “ <b>ON</b> ” indicates the control panel has been turned on. When there is failure-level error, this button will turn to <b>OFF</b> once the control panel is automatically turned off.
9	GENERAL	Go to the general parameter setting page.
10	Homepage	Back to the home page.

Icon	Description	Icon	Description
	Heating		Floor commissioning
	Cooling		Floor commissioning error
	Hot water		Card out
	Heating + Hot water		Defrosting
	Hot water + Heating		Holiday
	Cooling + Hot water		WiFi
	Hot water + Cooling		Back
	Quiet		Menu page
	Sanitation		Save
	Emergency		Error
	EVU		Weather depend

[Notes]

- The “Cooling” mode is unavailable to the heating only unit.
- The “Hot water” mode is unavailable when there is no water tank.

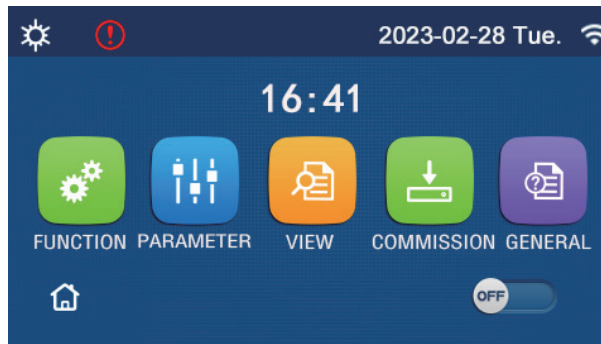

Error Icon

### 2.3 Backlight

Among the general setting page, when “Back light” is set to “Energy save”, the display panel will light off when there is no operation in 5 minutes. However, it will light on again by touching any valid area.

When “Back light” is set to “Lighted”, the display panel will be kept lighting on.

It is suggested to set it to “Energy save” so as to extend its service life.



### 3 Operation Instructions to the Controller

#### 3.1 ON/OFF

[Operation Instructions]

At the menu page, by touching ON/OFF, the control panel will be turned on/off.

[Notes]

- It is defaulted to be OFF upon first power-on.
- ON/OFF operation will be memorized by setting “**On/Off Memory**” to be “**On**” at the “**GENERAL.**” setting page.

That is, in case of power failure the control panel will resume running upon power recovery. Once “**On/off Memory**” is set to be “**Off**”, in case of power failure the control panel will keep “**Off**” upon power recovery.

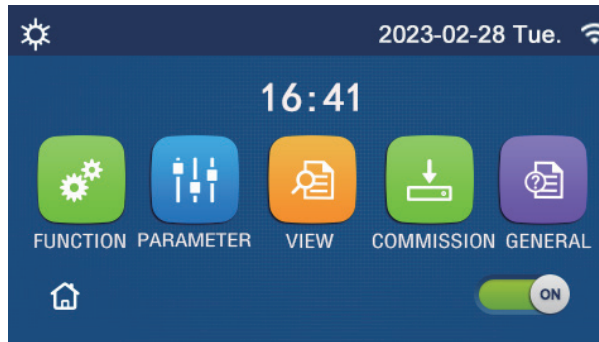

ON Page

#### 3.2 Function Setting

[Operation Instructions]

1. At the menu page, by touching “**FUNCTION**”, it will go to the function setting page as shown in the figure below.

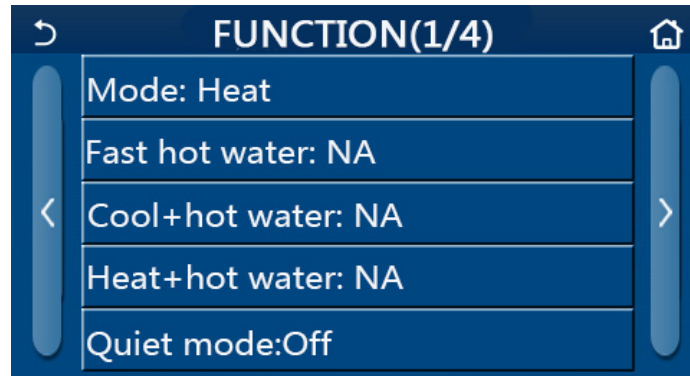

FUNCTION Setting Page

2. At the function setting page, by touching the page turning key, it will go to the last or next page. When setting is finished, by touching the menu page icon, it will directly back to the menu page; by touching the back icon, it will back to the upper menu.

3. At the function setting page, by pressing the desired function, it will go to the corresponding setting page of this option.

4. At the function setting page of some function option, by touching “**OK**”, this setting will be saved; by touching the “**CANCEL**” key, this setting will be canceled.

[Notes]

• At the function setting page with setting of any function changed, if the function is set to be memorized upon power failure, this setting will be saved automatically and memorized upon next power-on.

• When there is submenu for the selected function option, by pressing it the control will go directly the setting page of the submenu.

• The system is preconfigured by the installer. Some options may not be available or NA.

## Function Setting

No.	Item	Range	Default	Remarks
1	Mode	Cool	Heat	1. When the water tank is unavailable, then only "Cool" and "Heat" are available.
		Heat		
		Hot water		
		Cool + Hot water		
		Heat + Hot water		
2	Fast hot water	On/Off	Off	When the water tank is unavailable, it will be reserved.
3	Cool + hot water	Cool/Hot water	Hot water	When the water tank is available, it will be defaulted to be "Hot water"; when unavailable, it will be reserved.
4	Heat + hot water	Heat/Hot water	Hot water	When the water tank is available, it will be defaulted to be "Hot water"; when unavailable it will be reserved.
5	Quiet mode	Off/One time/ Always ON/ Timer	Off	/
6	Weather depend	On/Off	Off	/
7	Weekly timer	On/Off	Off	/
8	Holiday release	On/Off	Off	
9	Disinfection	On/Off	Off	When the water tank is unavailable, it will be reserved The disinfection date ranges from Monday to Sunday. Saturday is defaulted. 23:00. The disinfection time ranges from 00:00~23:00. 23:00 is defaulted.
10	Clock timer	On/Off	Off	/
11	Temp. timer	On/Off	Off	/
12	Emergen. mode	On/Off	Off	/
13	Holiday mode	On/Off	Off	/
14	Preset mode	On/Off	Off	/
15	Error reset	/	/	Some error can be cleared only when it has been reset manually.
16	WiFi reset			It is used to reset the WiFi.
17	Reset	/	/	It is used to reset all user parameter setting.
18	Child Lock	On/Off	Off	/
19	Daylight Saving Time	On/Off	Off	Time lag: 0.5~3h, 1 defaulted. Time lead: 0.5~3h, 1 defaulted. Transform time point: 0:00~3:00

## 3.2.1 Mode

[Operation Instructions]

At the function setting page with the control panel being turned off, by touching "Mode", it will go to the mode setting page, where desired mode can be selected. Then by touching "OK" this setting will be saved and the display panel will back to the function setting page.

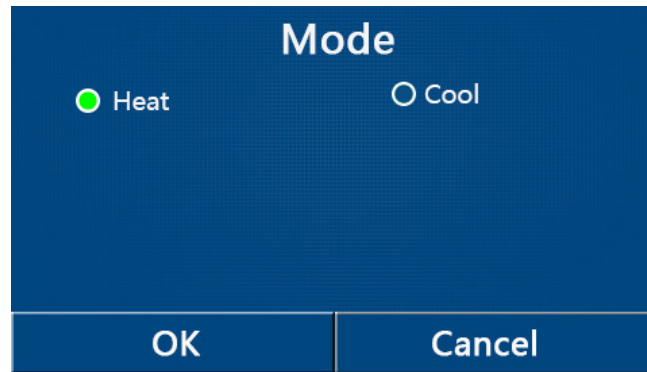

[Notes]

- The default mode is **“Heat”** upon first power-on.
- Mode setting is allowed only when the control panel is turned off, otherwise a dialog box will pop up, saying “Please turn off the system first!”
- When the water tank is unavailable, only **“Heat”** and **“Cool”** mode are allowed.
- When the water tank is available, **“Cool”**, **“Heat”**, **“Hot water”**, **“Cool+ Hot water”**, and **“Heat+ Hot water”** are allowed.
- For the heat pump, the **“Cool”** mode is allowed; for the heating only unit, **“Cool+ Hot water”** and **“Cool”** are unallowable.
- This setting can be memorized upon power failure.

### 3.2.2 Fast hot water

[Operation Instructions]

At the function setting page with the control panel being turned off, by touching **“Fast hot water”**, the display panel will go to the corresponding setting page, where desired option can be selected. Then by pressing **“OK”** this setting will be saved and the display panel will back to the function setting page.

[Notes]

- This function can be set to **“On”** only when the water tank is available. When the water tank is unavailable, this function will be reserved.
- It will be memorized upon power failure.

### 3.2.3 Cool + hot water

[Operation Instructions]

At the function setting page with the control panel being turned off, by touching **“Cool + hot water”**, the display panel will go to the corresponding setting page, where desired option can be selected. Then by pressing **“OK”** this setting will be saved and the display panel will back to the function setting page.

[Notes]

- When the water tank is unavailable, it will be reserved; when it is unavailable, the default priority will be given to **“How water”**.
- It will be memorized upon power failure.
- This function is unavailable to mini chillers.

### 3.2.4 Heat + hot water

[Operation Instructions]

At the function setting page with the control panel being turned off, by touching **“Heat + hot water”**, the display panel will go to the corresponding setting page, where desired option can be selected. Then by pressing **“OK”** this setting will be saved and the display panel will back to the function setting page.

[Notes]

- When the water tank is unavailable, it will be reserved; when it is unavailable, the default priority will be given to **“Hot water”**.

- It will be memorized upon power failure.
- This function is unavailable to the heating only unit and the mini chiller.

### 3.2.5 Quiet mode

[Operation Instructions]

At the function setting page with the control panel being turned off, by touching “**Quiet mode**”, there will be a choice box, where “**Quiet mode**” can be set to “**Off**”, “**One time**”, “**Timer**” or “**Always ON**”.

When it is set to “**One time**”, it will automatically back to “**Off**” when the main unit is turned off.

When it is set to “**Always ON**”, this function can be deactivated only through changing its setting, and would not be deactivated as the main unit is turned off.

When it is set to “**Timer**”, it is also required to set the “**Start timer**” and “**End timer**”. Unless otherwise stated, otherwise time setting is all the same.

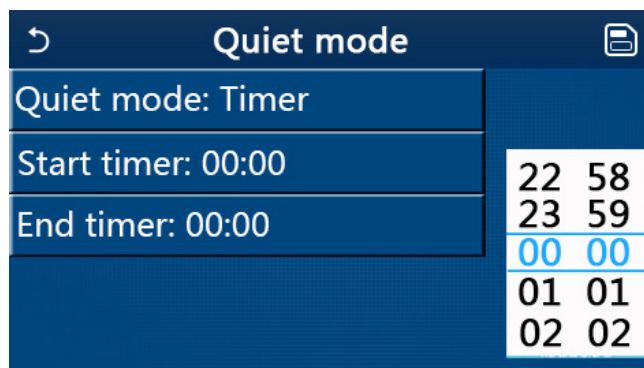

Timer for Quite Mode

This setting will be saved by touching the corner at the upper right corner.

[Notes]

- It can be set under both ON and OFF statuses, but will work only when the main unit is turned on.
- It will be memorized upon power failure.

### 3.2.6 Weather depend

[Operation Instructions]

At the function setting page, by touching “**Weather depend**”, there will be a choice box, where it is able to set it to “**On**” or “**Off**”, and also it is able to set the weather-dependent temperature.

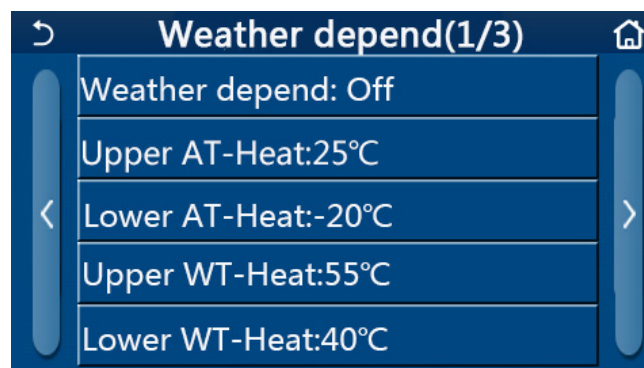

Page of the Weather Depend

[Notes]

- When “**Weather depend**” has been activated; it cannot be deactivated by ON/OFF operation but done manually.
  - It is available to find the weather-dependent target temperature at that parameter viewing pages.
  - When this function has been activated, it is still allowed to set the room temperature, however, this setting becomes valid only when “**Weather depend**” has been deactivated.
  - This function can be set to “**On**” no matter the control panel is turned on or off, but works only when the main unit is turned on.

- It works under the “Cool” or “Heat” mode. Under the “Cool +Hot water” or “Heat +Hot water” modes, it works only when the current mode is “Cool” or “Heat”. Under the “Hot water” mode, it doesn’t work.

- Temperature setting relative to the cooling mode is unallowed to the heating only unit.

- It will be memorized upon power failure.

- When the set point of “Upper WT-Heat”/ “Upper WT-Cool” is lower than that of the “Lower WT-Heat”/ “Lower WT-Cool”, or “Lower WT-Heat”/ “Lower WT-Cool” is higher than “Upper WT-Heat”/ “Upper WT-Cool”, a window will pop up, saying “Enter wrong!”, and then resetting is required.

### 3.2.7 Weekly timer

[Operation Instructions]

1. At the function setting page, by touching “Weekly timer”, it will go to the setting page as shown below.

Weekly timer	
Weekly timer: Off	
Mon. : Invalid	Tue. : Invalid
Wed. : Invalid	Thur. : Invalid
Fri. : Invalid	Sat. : Invalid
Sun. : Invalid	

2. At the “Weekly timer” setting page, as shown in the figure below, the weekly timer can be set to “On” or “Off”.

3. At the “Weekly timer” setting page, by touching the desired day (Monday~Sunday) it will go to the setting page of this option.

4. At the weekday setting page, it is able to set the timer to “Valid” or “Invalid”. Also, it is able to set three timing periods, each of which can be set to “Valid” or “Invalid”.

5. Then, by touching the “Save” icon, this setting will be saved.

[Notes]

- Three periods can be set for each day. The start time should be earlier than the end time for each period, otherwise this setting will be invalid. In the same way, the latter should be earlier than the former.

- When the weekly timer has been activated, the display panel will act based on the current mode and temperature setting.

- Timer setting for the weekday

“Valid” it indicates this setting works only when “Weekly timer” has been activated, unaffected by the holiday mode.

“Invalid” indicates this setting does not work even though the “Weekly timer” has been activated.

- When both “Weekly timer” and “Holiday release” have been activated, setting of “Weekly timer” is invalid. Only when “Holiday release” has been deactivated, setting of “Weekly timer” works.

- The priority sequence for timer setting from high to low is “Temperature timer”, “Clock timer”, “Preset mode” and “Weekly timer”. Setting with lower priority sequence is allowed but does not work when setting with higher priority has been activated. However, it will work when the setting with higher priority has been deactivated.

- It will be memorized upon power failure.

### 3.2.8 Holiday release

[Operation Instructions]

At the function setting page, by touching “Holiday release”, it will go to the corresponding setting page, where it can be set to “On” or “Off”.

[Notes]

- When this function has been activated, at the **“Weekly timer”** setting page, some week day can be set to **“Holiday release”**. In this case, the setting of the **“Weekly timer”** at this day is invalid unless it has been manually set to **“Valid”**.
- It will be memorized upon power failure.

### 3.2.9 Disinfection

[Operation Instructions]

This function is intended to destroy bacteria inside the water tank through high temperature.

- 1.At the function setting page, go to **“Disinfection”** setting page.
- 2.At the **“Disinfection”** setting page, it can select the disinfection clock, disinfection temperature and disinfection week and the corresponding setting page will pop up at the right side.
- 3.Then, this setting will be saved by touching the **“Save”** icon.

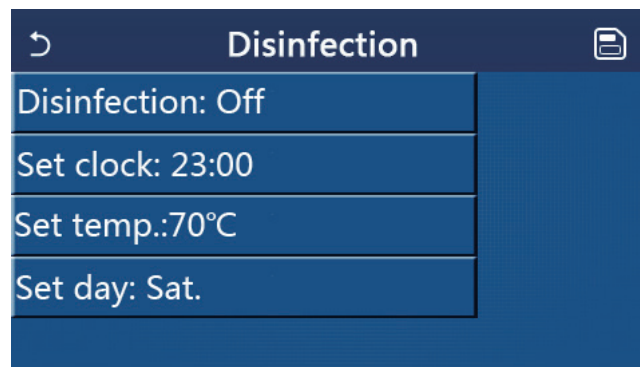

[Notes]

- This setting can be activated only when **“Water tank”** is set to **“With”**. When **“Water tank”** is set to **“Without”**, this function will be deactivated.
- This setting can be done no matter if the control panel is turned on or off.
- When **“Emergen.mode”**, **“Holiday mode”**, **“Floor debug”**, **“Manual defrost”**, or **“Refri. recovery”** has been activated, this function cannot be activated at the same time. When **“Disinfection”** has been activated, **“Emergen.mode”**, **“Holiday mode”**, **“Floor debug”**, **“Manual defrost”**, or **“Refri. recovery”** setting will fail and a window will pop up, saying **“Please disable the disinfect mode!”**
- “Disinfection”** can be activated no matter if the control panel is turned on or off. This mode will take priority over the **“Hot water”** mode.
- When disinfection operation fails, the display panel will tell **“Disinfection fail!”**. Then, by pressing OK it will be cleared.
- When **“Disinfection”** has been activated, if communication error with the indoor unit or malfunction of the water tank heater occurs, it will automatically quit.
- It will be memorized upon power failure.

### 3.2.10 Clock timer

[Operation Instructions]

- 1.At the function setting page, go to the **“Clock timer”** setting page.
- 2.At the **“Clock timer”** setting page, it can be set to **“On”** or **“Off”**.

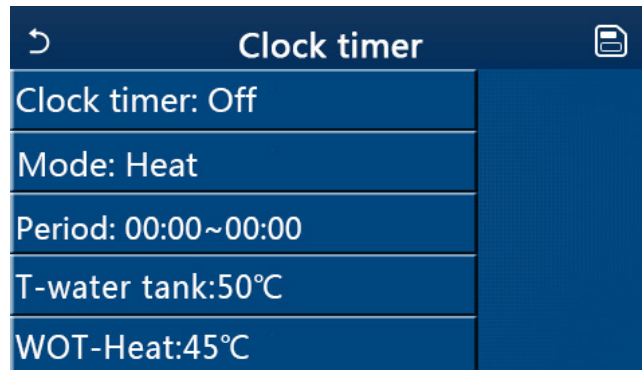

3.The option “**Mode**” is used to time the desired mode; “**WOT-Heat**” and “**T-water tank**” is used to set the corresponding water temperature; “**Period**” is used to for time setting. After that, by touching the “**Save**” icon, all settings will be saved.

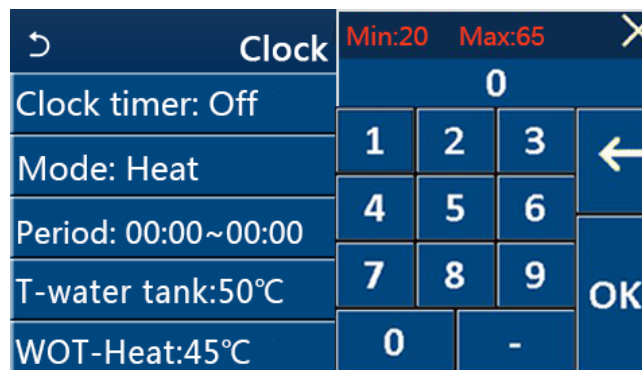

[Notes]

- When “**Clock timer**” has been set and “**Hot water**” mode is involved, in this case, if “**Water tank**” is changed to “**Without**”, “**Hot water**” will be automatically switched to “**Heat**”, and “**Cool/Heat + Hot water**” will be switched to “**Cool/Heat**”.

- When “**Weekly timer**” and “**Clock timer**” have been set at the same time, the priority will be given to the former.

- When the water tank is available, “**Heat**”, “**Cool**”, “**Hot**”, “**Heat + Hot water**”, and “**Cool + Hot water**” are allowed; however, when the water tank is unavailable, only “**Heat**” and “**Cool**” are allowed.

- When the end time is earlier than the start time, this setting is invalid.

- Water tank temperature can be set only when “**Hot water**” is involved in the operation mode.

- The setting of “**Clock timer**” only works once. If this setting is needed again, it should be set again.

- It will be deactivated when the main unit is turned on manually.

- When “**Weather depend**” has been activated and the mode for “**Clock timer**” is set to “**Hot water**”, “**Weather depend**” will be deactivated when the setting mode has been switched.

- This function will be memorized upon power failure.

### 3.2.11 Temp. timer

At the function setting page, go to the “Temp.timer” setting page.

At the “Temp.timer” setting page, it can be set to “On” or “Off”.

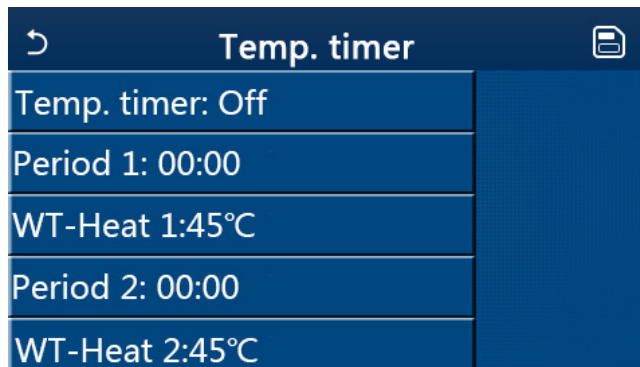

Select “Period 1”/“Period 2” and a window will pop up, where time period can be set. Then select “WT-Heat1/WT-Cool 1/2” and also a window will pop up where temperature can be set.

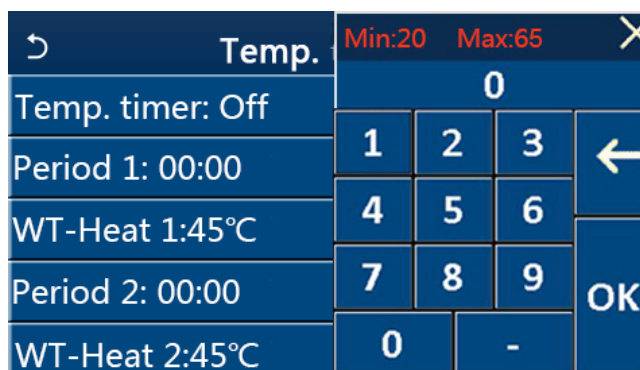

[Notes]

- When “Weekly timer”, “Preset mode”, “Clock timer” “Temp. timer” have been set at the same time, then the latter takes the priority.
- This setting is valid only when the control panel is turned on.
- Under the “Cool” or “Cool+Hot water” mode, the setting targets at “WT-Cool”; while under the “Heat” or “Heat+Hot water” mode, the setting targets at “WT-Heat”.
- When start time of period 2 is the same as that of period 1, then the former takes prevalence.
- “Temp.timer” is judged based on timer.
- During this setting, when temperature is set manually, then this setting will take prevalence.
- Under the “Hot water” mode, this function will be reserved.
- This function will be memorized upon power failure.

### 3.2.12 Emergen. mode

[Operation Instructions]

This function is intended to start other heat source to provided uninterrupted heating in case that the heat pump fails.

- 1.At the function setting page, set the mode to “Heat” or “Hot water”.
- 2.At the function setting page, select “Emergen.mode” and set it to “On” or “Off”.
- 3.When “Emergen.mode” has activated, the corresponding icon will appear at the upper side of the menu page.
- 4.When the mode is not set to “Heat” or “Hot water”, the display panel will tell “Wrong running mode!”

[Notes]

- The emergency mode is allowed on conditions that there is some error or protection and the compressor has stopped at least for three minutes. If the error or protection has not been recovered, the main unit can go to the emergency mode through the wired controller (when the control panel is off).
- Under the emergency mode, “Hot water” or “Heat” cannot be performed at the same time.



- When the running mode is set to “Heat”, if “Other thermal” or “Optional E-Heater” is set to “Without”, the main unit will fail to go to the “Emergen. mode”.

- When the main unit performs “Heat” under “Emergen. mode” and the control panel detects “HP-Water Switch”, “Aux. heater 1”, “Aux. heater 1”, and “Temp-AHLW”, this mode will quit at once. In the same way, when errors mentioned above occur, “Emergen. mode” cannot be activated.

- When the main unit performs “Hot water” under “Emergen. mode” and the control panel detects “Aux.-WTH”, this mode will quit at once. In the same way, when errors mentioned above occur, “Emergen. mode” cannot be activated.

- When this function has been activated, “Weekly timer”, “Preset mode”, “Clock timer”, and “Temp timer” will be deactivated. Beside “On/Off”, “Mode”, “Quiet mode”, “Weekly timer”, “Preset mode”, “Clock timer”, and “Temp timer” operation are unavailable.

- Under “Emergen. mode”, the thermostat does not work.

- This function can be activated only when the control panel is turned off. If doing so with the control panel “On”, a window will pop up, saying “Please turn off the system first!”.

- “Floor debug”, “Disinfection”, and “Holiday mode” cannot be activated at the same with this function. When doing so, a window will pop up, saying “Please disable the emergen. mode!”.

- Upon power failure, “Emergen. mode” will back to “Off”.

### 3.2.13 Holiday mode

[Operation Instructions]

This function is intended to let the heat pump run under the energy conservation mode so as to keep the room temperature within a certain range, which then will prevent pipelines from suffering frostbites.

At the function setting page, select “Holiday mode” and set it to “On” or “Off”.

[Notes]

- This function can be activated only when the control panel has been turned off, otherwise a prompt dialog box will pop up, saying “Please turn off the system first!”.

- When “Holiday mode” has been activated, the operation mode will automatically switch to “Heat”. Mode setting and “On/Off” operation through the control panel will be unavailable.

- When “Holiday mode” has been activated, the control panel will automatically deactivate the “Weekly timer” and “Preset mode” and “Clock timer” and “Temp.timer”.

- Under the “Holiday mode”, when the main unit is under the control of room temperature, the set point (room temperature for heating) should be set to 10°C; when it is under the control of leaving water temperature, the set point (leaving water temperature for heating) should be 30°C.

- When this function has been activated, “Floor debug”, “Emergen.mode”, “Disinfection”, “Manual defrost”, “Preset mode”, “Weekly timer”, “Clock timer”, and “Temp.timer” cannot be activated at the same time, meanwhile a window will pop up, saying “Please disable the holiday mode!”.

- This function will be memorized upon power failure.

### 3.2.14 Preset mode

[Operation Instructions]

At the function setting page, select “**Preset mode**” and go to the corresponding setting page.

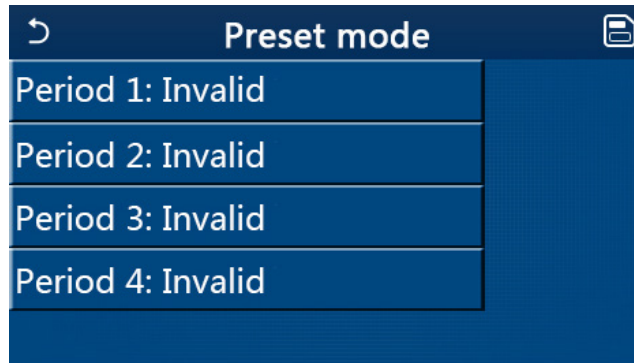

At the time period setting page, each time period can be set to “**Valid**” or “**Invalid**”.

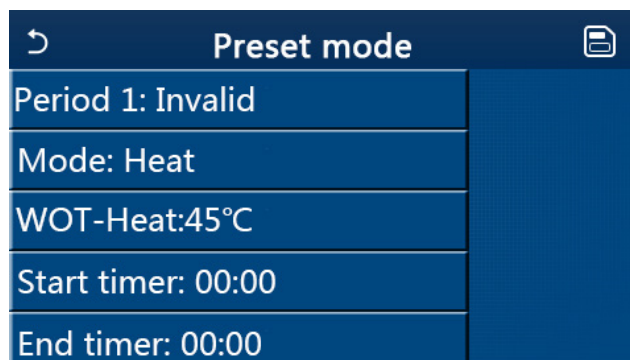

The option “**Mode**” is used to preset the mode; “**WOT-Heat**” is used to set the leaving cold/hot water temperature; “**Start timer**”/“**End timer**” is used to for time setting. After that, by touching the “**Save**” icon, all settings will be saved.

[Notes]

- When “**Preset mode**” has been set to “**Hot water**” and “**Water tank**” is to set to “**Without**”, the preset “**Hot water**” mode will be automatically switched to “**Heat**”.
- When “**Weekly timer**” and “**Preset mode**” both have been set, priority will be given to the latter.
- When the water tank is available, the preset mode can be “**Heat**”, “**Cool**”, or “**Hot water**”; however, when the water tank is unavailable, the preset mode can only be “**Heat**” or “**Cool**”.
- “**Start timer**” should be earlier than “**End timer**”, otherwise a dialog will pop up, saying “**time setting wrong**”.
- The setting for “**Preset mode**” will works until it has been canceled manually.
- When “**Start timer**” is reached, the main unit will perform the preset mode. In this case, mode and temperature setting are still allowed but will not be saved to the preset mode. When “**End timer**” is reached, the control panel will perform OFF operation.
  - This function will be memorized upon power failure.
  - When “**Weather depend**” has been activated and the mode for “**Preset mode**” is set to “**Hot water**”, “**Weather depend**” will be deactivated when the setting mode has been switched.

### 3.2.15 Error reset

[Operation Instructions]

This function is intended to manually clear errors, which then will enable the heat pump to execute the startup command.

At the function setting page, by touching “**Error reset**”, a choice box will pop up, where by touching “**OK**” the error will be reset and by touching “**Cancel**” the error will not be reset.

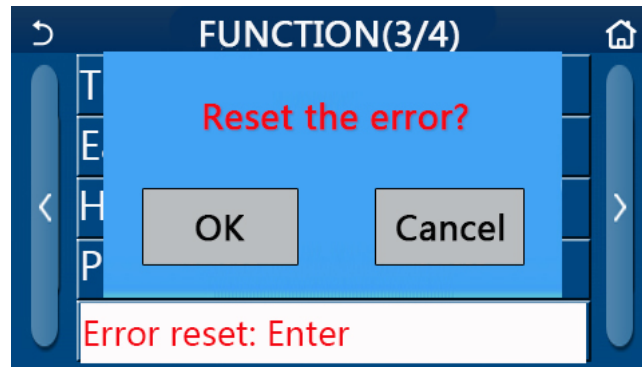

[Notes]

- It can be performed only when the control panel is turned off.

### 3.2.16 Disinfection WiFi reset

[Operation Instructions]

At the function setting page, by touching “WiFi reset”, a choice box will pop up, where by touching “OK”, the WiFi setting will be reset, and by touching “Cancel” the choice box will quit and WiFi will not be reset.

### 3.2.17 Reset

[Operation Instructions]

At the function setting page, by touching “Reset”, a choice box will pop up, where by touching “OK” all user parameter settings will be reset and by touching “Cancel” it will back to the function setting page.

[Notes]

- This function is allowed only when the control panel has been turned off.
- This function is valid for “Temp. timer”, “Clock timer”, “Preset mode”, “Weekly timer”, and “Weather depend”.

### 3.2.18 Child lock

[Operation Instructions]

At the function setting page, by touching “Child Lock”, it can be set to “On” or “Off”.

When it is set to “On”, the control panel will go back to the home page and a lock icon  will be displayed, as shown in the figure below.

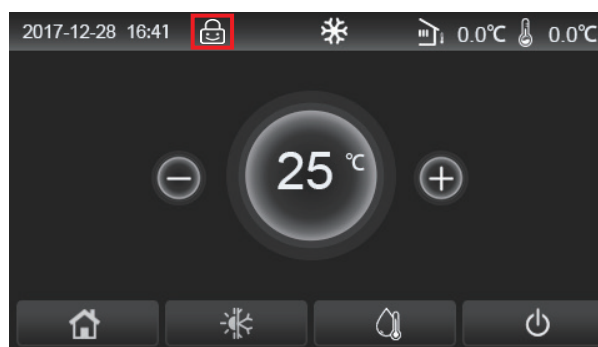

In this case, the control panel is locked and any touch operation does not work. By touching  for six seconds, the control panel will be unlocked and touch operation will work. However, the setting of “Child Lock” will remain to be “On”, and if there is no any operation in 30 seconds, the control panel will be locked again.

Only when it is set to “Off”, this function will be really disenabled.

### 3.2.19 Daylight saving time

[Operation Instructions]

When it has been activated, it allows to set “Time lag”, “Time lead” and “Transform time”. The system clock of the control panel will be delayed for some time at the “Transform time” of last Sunday in March, and will be advanced for some time at the “Transform time” of last Sunday in October.

“Time lag” is used for March and “Time lead” is for October.

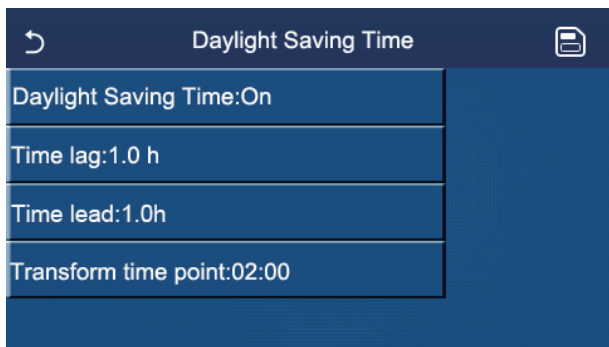

For example, if March 30 is the last Sunday of this month, when the system clock goes to March 30, 2:00, the system clock will be lagged automatically for one hour. That is, the displayed system time will become to be March 30, 3:00.

For example, if October 30 is the last Sunday of this month, when the system clock goes to October 30, 2:00, the system clock will be advanced automatically for one hour. That is, the displayed system time will become to be October 30, 1:00.

When there is a timer setting at the “Time lag” period, then this timer setting goes invalid in this period.

### 3.3 User Parameter Setting

[Operation Instructions]

1.At the menu page, by touching “PARAMETER”, it will back to the parameter setting page, as shown in the figure below.

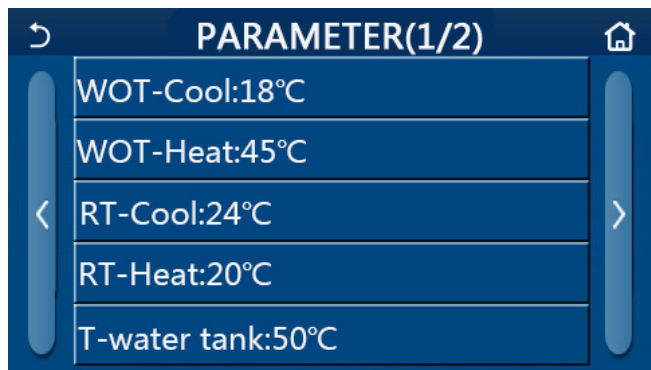

Parameter Setting Page

2.At the menu setting page, by touching the page turning keys, it is able to switch to the page where the desired parameter is.

3.After that, this setting will be saved by touching “OK” and then the main unit will run based on this setting. While this setting will give up by touching “Cancel”.

[Notes]

For parameters with different defaults under different conditions, when conditions changes, the default value also will change as the corresponding condition changes.

All parameters will be memorized upon power failure.

## Parameter Setting

No.	Full Name	Displayed Name	Range	Range	Default	Remarks
			(°C)	(°F)		
1	Leaving water temperature for cooling	WOT-Cool	5~25°C	41~77°F	18°C /64°F	/
2	Leaving water temperature for heating	WOT-Heat	20~65°C	68~149°F	45°C/113°F	/
3	Room temperature for cooling	RT-Cool	18~30°C	64~86°F	24°C/75°F	
4	Room temperature for heating	RT-Heat	18~30°C	64~86°F	20°C/68°F	/
5	Water tank temperature	T-water tank	40~80°C	104~176°F	50°C/122°F	/
6	Leaving water temperature difference for cooling	ΔT-Cool	2~10°C	36~50°F	5°C/41°F	/
7	Leaving water temperature difference for heating	ΔT-Heat	2~10°C	36~50°F	10°C/50°F	/
8	Leaving water temperature difference for water heating	ΔT-hot water	2~25°C	36~77°F	5°C/41°F	/
9	Room temperature control difference	ΔT-Room temp	1~5°C	34~41°F	2°C/36°F	/
10	Temperature difference between actual and target water for cooling	ΔWT-Cool AT	-10~0°C	14~32°F	-5°C/23°F	/
11	Temperature difference between actual and target water for heating	ΔWT-Heat AT	0~15°C	32~59°F	5°C/41°F	/
12	Temperature difference between actual and target water for water heating	ΔWT-hot water AT	0~15°C	32~59°F	5°C/41°F	/
13	Minimal allowable water temperature by users	WT min	5~25°C	41~77°F	5°C/41°F	/
14	Maximal allowable water temperature by users for heating	WT-Heat max	20~65°C	68~149°F	65°C/149°F	/
15	Maximal allowable water temperature by users for water heating	WT-Hot water max	40~80°C	104~176°F	80°C/176°F	/
16	Leaving water temperature setting range for cooling	WOT-Cool Range	5~25°C	41~77°F	10°C/50°F	/
17	Leaving water temperature setting range for heating	WOT-Heat Range	20~65°C	68~149°F	55°C/131°F	/
19	Leaving water temperature setting range for water heating	T-water tank Range	40~80°C	104~176°F	60°C/140°F	/

Parameters from No.10 to No.19 are for setting target water temperature under the SG function. When SG (smart grid) has been activated, the unit after receiving the grid signal will go under the control as stated below.

Running mode	Target water temperature			
	Switch-on signal	Switch-on command	Standard operation	Switch-off command
Cool	Take the larger between (WOT-Cool+ $\Delta$ deWT-Cool AT) and WT min.	Take the larger between WOT-Cool Range and WT min.	WOT-Cool	/
Heat	Take the smaller between (WOT-Heat+ $\Delta$ WT-Heat AT) and WT-Heat max.	When the electric heater works, take the smaller between WOT-Heat Range and WT-Heat max.	WOT-Heat	/
		When the electric heater does not work, take the smaller between WOT-Heat Range and Tmax. Tmax is the highest leaving water temperature corresponding to the current ambient temperature.		/
Hot water	Take the smaller between (T-water tank+ $\Delta$ WT-hot water AT) and WT-hot water max.	When the electric heater works, take the smaller between T-water tank Range and WT-hot water max.	T-water tank	/
		When the electric heater does not work, take the smaller between T-water tank Range and T-HP max.		/

### 3.4 Viewing

[Operation Instructions]

1. At the menu page, by touching "VIEW", the control panel will go to the sub-menu page as shown in the figure below. On this page, some functions, such as error log, will record error information to the local but not upload it to the network.

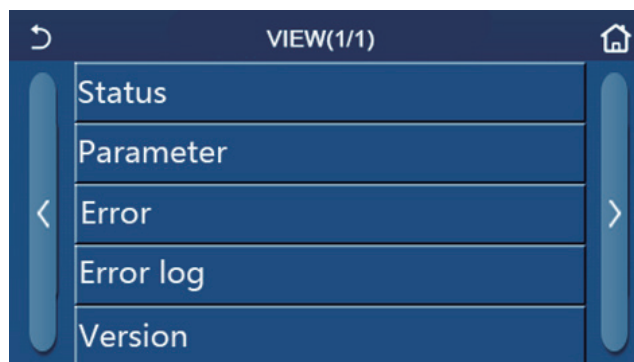

VIEW Page

### 3.4.1 Status

[Operation Instructions]

1. At the "VIEW" page, by touching "Status", it is able to view status of the main unit, as shown in the figure below.

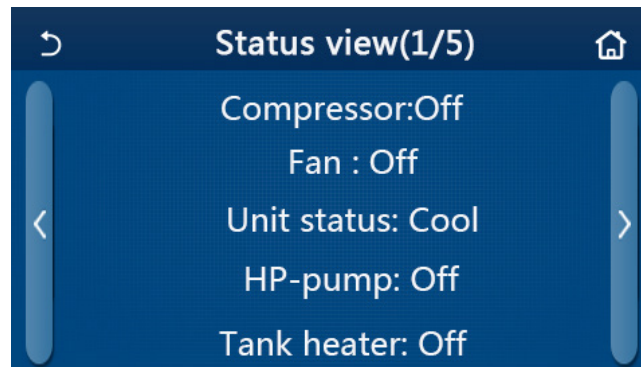

Status View Page  
Viewable Status

No.	Full Name	Displayed Name	Status
1	Status of the compressor	Compressor	On/Off
2	Status of the fan	Fan	On/Off
3	Status of the main unit	Unit status	Cool/Heat/Hot water/Off
4	Status of the water pump	HP-pump	On/Off
5	Status of the water tank heater	Tank heater	On/Off
6	Status of the 3-way valve 1	3-way valve 1	NA
7	Status of the 3-way valve 2	3-way valve 2	On/Off
8	Status of the compressor crankcase heater	Crankc. heater	On/Off
9	Status of the heater 1 for the main unit	HP-heater 1	On/Off
10	Status of the heater 2 for the main unit	HP-heater 2	On/Off
11	Status of the Chassis heater	Chassis heater	On/Off
12	Status of the heat exchanger heater	Plate heater	On/Off
13	Status for the system defrosting	Defrost	On/Off
14	Status of the system oil return	Oil return	On/Off
15	Status of the thermostat	Thermostat	Off/Cool/Heat/Hot water/Cool+hot water/Heat+hot water
16	Status of other thermal source	Other thermal	On/Off
17	Status of the 2-way valve	2-way valve	On/Off
18	Status of antifreeze	HP-Antifree	On/Off
19	Status of the door guard	Gate-Ctrl.	Card in/Card out
20	Status of the 4-way valve	4-way valve	On/Off
21	Status of disinfection	Disinfection	Off/Running/Done/Fail
22	Status of the flow switch	Flow switch	On/Off
23	Status of the tank pump	Tank pump	On/Off
24	SG signal	SG signal	On/Off
25	EVU signal	EVU signal	On/Off
26	SG control command	SG	Switch-off command/Standard operation/Switch-on signal/Switch-on command

### 3.4.2 Parameter

[Operation Instructions]

1. At the “VIEW” page, by touching “Parameter”, it is able to view each parameter of the main unit, as shown in the figure below.

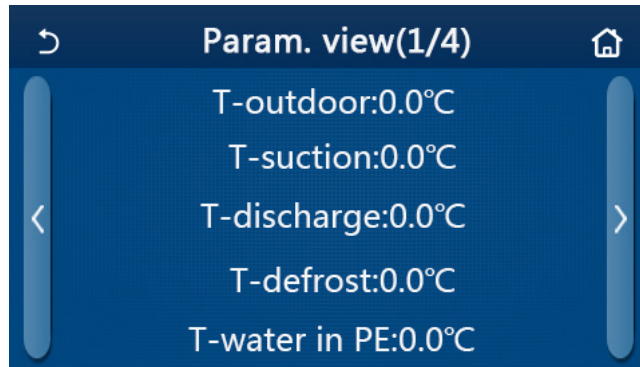

Parameter View Page  
Viewable Parameters

No.	Full Name	Displayed Name
1	Environmental temperature	T-outdoor
2	Suction temperature	T-suction
3	Discharge temperature	T-discharge
4	Defrosting temperature	T-defrost
5	Entering water temperature of the plate type heat exchanger	T-water in PE
6	Leaving water temperature of the plate type heat exchanger	T-water out PE
7	Leaving water temperature of the auxiliary heater	T-optional water Sen.
8	Water tank temperature	T-tank ctrl.
9	Floor debug target temperature	T-floor debug
10	Floor debug runtime	Debug time
11	Liquid line temperature	T-liquid pipe
12	Vapor line temperature	T-gas pipe
13	Economizer inlet temperature	T-economizer in
14	Economizer outlet temperature	T-economizer out
15	Remote room temperature	T-remote room
16	Discharge pressure	Dis. pressure
17	Weather-dependent target temperature	T-weather depend
18	Water flow feedback of the water pump	Water flow



### 3.4.3 Error

[Operation Instructions]

At the “VIEW” page, by touching “Error”, it is able to view errors of the main unit, as shown in the figure below.

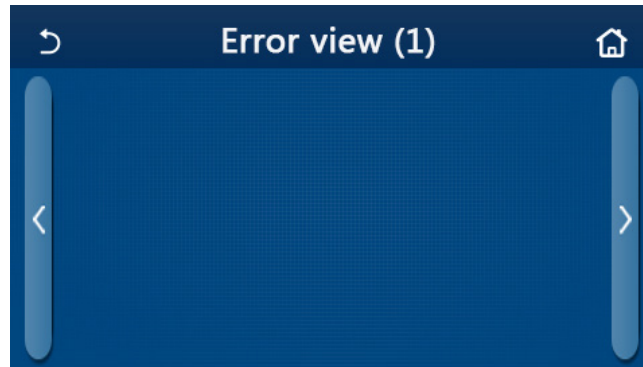

Error View Page

[Notes]

- The control panel can display real-time errors. And at these pages, all errors will be listed here.
- Each page displays at most 5 pieces of errors. Others can be viewed by touching the page turning keys.

#### Error List

No.	Full Name	Displayed Name
1	Ambient temperature sensor error	Ambient sensor
2	Defrosting temperature sensor error	Defrost sensor
3	Discharge temperature sensor error	Discharge sensor
4	Suction temperature sensor error	Suction sensor
5	Economizer inlet temperature sensor	Econ. in sens.
6	Economizer outlet temperature sensor	Econ. out sens.
7	Fan error	Outdoor fan
8	High pressure protection	High pressure
9	Low pressure protection	Low pressure
10	High discharge protection	Hi-discharge
11	Capacity DIP switch error	Capacity DIP
12	Communication error between the outdoor and indoor main boards	ODU-IDU Com.
13	Communication error between the outdoor main board and the drive board	Drive-main com.
14	Communication error between the display panel and indoor main board	IDU Com.
15	High pressure sensor error	HI-pre. sens.
16	Leaving water temperature sensor error for the plate type heat exchanger of the heat pump	Temp-HELW
17	Leaving water temperature sensor error for the auxiliary electric heat of the heat pump	Temp-AHLW
18	Entering water temperature sensor error of the plate type heat exchanger of the heat pump	Temp-HEEW
19	Water tank temperature sensor error	Tank sens.
20	Remote room temperature sensor error	T-Remote Air
21	Protection for the flow switch of the heat pump	HP-Water Switch
22	Welding protection to the auxiliary electric heater 1 of the heat pump	Auxi. heater 1
23	Welding protection to the auxiliary electric heater 2 of the heat pump	Auxi. heater 2
24	Welding protection to the water tank electric heater	Auxi. -WTH

No.	Full Name	Displayed Name
25	DC bus under-voltage or voltage drop error	DC under-vol.
26	DC bus over-voltage	DC over-vol.
27	AC current protection (input side)	AC curr. pro.
28	IPM defective	IPM defective
29	PFC defective	PFC defective
30	Start failure	Start failure
31	Phase loss	Phase loss
32	Jumper cap error	Jumper cap error
33	Driver resetting	Driver reset
34	Compressor overcurrent	Com. over-cur.
35	Overspeed	Overspeed
36	Current sensing circuit error or current sensor error	Current sen.
37	Desynchronization	Desynchronize
38	Compressor stalling	Comp. stalling
39	Radiator or IPM or PFC over-temperature	Overtemp.-mod.
40	Radiator or IPM or PFC temperature sensor error	T-mod. sensor
41	Charging circuit error	Charge circuit
42	AC input voltage error	AC voltage
43	Ambient temperature sensor error at the drive board	Temp-driver
44	AC contactor protection or input over-zero error	AC contactor
45	Temperature drift protection	Temp. drift
46	Sensor connection protection ( the current sensor fails to be connected with the corresponding phase U and or phase V)	Sensor con.
47	Communication error between the display panel and the outdoor unit	ODU Com.
48	Refrigerant vapor line temperature sensor error	Temp RGL
49	Refrigerant liquid line temperature sensor error	Temp RLL
50	4-way valve error	4-way valve

### 3.4.4 Error log

[Operation Instructions]

At the “VIEW” page, by touching “Error log”, the control panel will go to the error log page, where it is able to view error records.

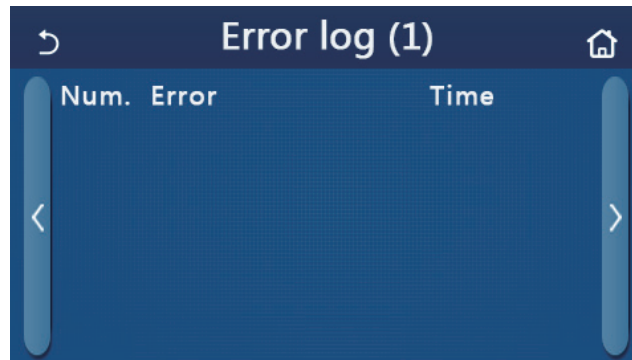

[Notes]:

- The error log can accommodate up to 20 pieces of error. Name and occurrence time are available for each error.
- When error log exceeds 20, the latest will supersede the earliest.

### 3.4.5 Version

[Operation Instructions]

At the “**VIEW**” page, by touching “**Version**”, the control panel will go to the version view page, where it is able to view both the program version and protocol version.

## 3.5 General Setting

[Operation Instructions]

1.At the menu page, by touching “**GENERAL**”, the control panel will go to the setting page, as shown in the figure below, where it is able to set “**Temp.unit**”, “**On/off memory**”, “**Beeper**”, “**Back light**”, “**Time & Date**” and “**Language**”.

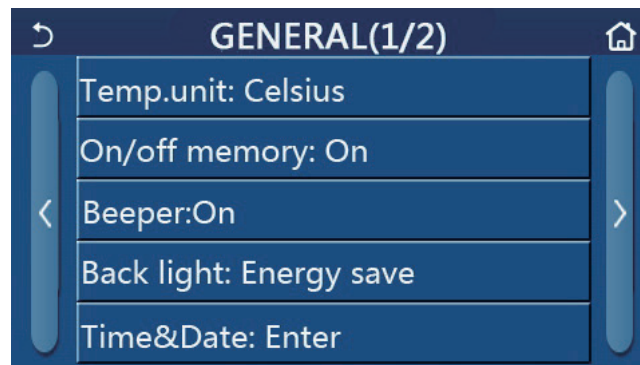

General Setting Page  
General Settings

No.	Item	Range	Default	Remarks
1	Temp. unit	°C/°F	°C	/
2	On/Off memory	On/Off	On	/
3	Beeper	Enter	On	/
4	Back light	Lighted/Energy save	Energy save	“ <b>Lighted</b> ”: the control panel will always light on. “ <b>Energy save</b> ”: When there is no touching operation in 5 minutes, the control panel will be lighted off automatically, but will light on again once there is any touching operation.
5	Time&Data	Enter	/	/
6	Language	Italiano/English/Español/ Nederlands/Français/Deutsch/ Български/Polски/Suomi/Svenska/ Türkçe/Magyar/Lietuvių/Hrvatski/ Čeština/Srpski/Slovenski/...	English	/
7	WiFi	On/Off	On	/

### 3.5.1 Time and clock

[Operation Instructions]

1.At the “**GENERAL**” setting page, by touching “**Time&Data**”, it will go to the setting page as shown in the figure below.

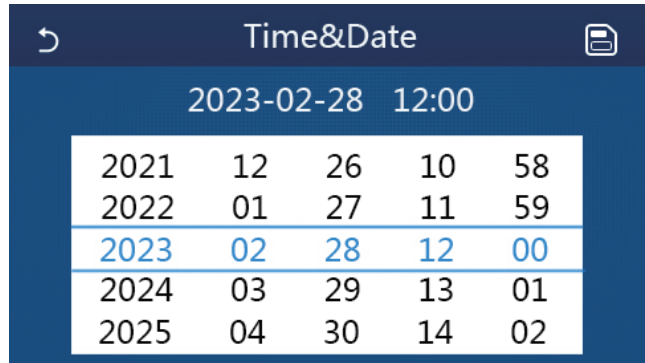

Time & Date Page

2.The roller indicated by the red circle as shown in the figure below can change the date and time value. After it, by touching the “**Save**” icon, this setting will be saved and directly displayed; while by touching the “**Back**” icon, this setting will give up and the control panel will directly go back to the “**GENERAL**” setting page.

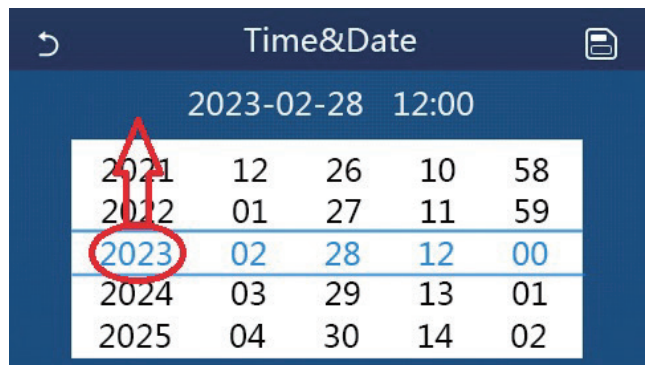

Time & Date Page

## 4. Troubleshooting and Maintenance

### 4.1 Daily Operation and Maintenance

In order to avoid damage of the unit, all protecting devices in the unit had been set before delivery, so please do not adjust or remove them.

For the first startup of the unit or next startup of unit after long-period stop (above 1 day) by cutting off the power, please electrify the unit in advance to preheat the unit for more than 8 hours.

Never put sundries on the unit and accessories. Keep dry, clean and ventilated around the unit.

Remove the dust accumulated on the condenser fin timely to ensure performance of the unit and to avoid stop of the unit for protection.

In order to avoid protection or damage of the unit caused by blockage of the water system, clean the filter in water system periodically and frequently check water replenishing device.

In order to ensure anti-freezing protection, never cut off the power if ambient temperature is below zero in winter.

In order to avoid frost crack of the unit, water in the unit and pipeline system not used for a long period should be drained. In addition, open the end cap of the water tank for drainage.

When the water tank has been installed but the water tank is set to "Without", functions relative with the water tank will not work and the displayed water tank temperature will always be "-30". In this case, the water tank would suffer frostbite and even other severe influences under low temperature. Therefore, once the water tank has been installed, the water tank must be set to "With", otherwise AlpicAir will not be responsible for this abnormal operation.

Never frequently make the unit on/off and close the manual valve of the water system during operation of the unit by users.

Ensure frequent check to the working condition of each part to see if there is oil stain at pipeline joint and charge valve to avoid leakage of refrigerant.

If malfunction of the unit is out of control of users, please timely contact with authorized service center.

#### Notes

(a) The water pressure gage is installed in the returning water line in the unit. Please adjust the hydraulics system pressure according to next item:

- If the pressure is less than 0.5 bar, please recharge the water immediately;
- When recharging, the hydraulics system pressure should be not more than 2.5 Bar.

Malfunctions	Reasons	Troubleshooting
Compressor does not start up	Power supply has problem. Connection wire is loose. Malfunction of mainboard. Malfunction of compressor.	Phase sequence is reverse. Check out and re-fix. Find out the reasons and repair. Replace compressor.
Heavy noise of fan	Fixing bolt of fan is loose. Fan blade touches shell or grill. Operation of fan is unreliable.	Re-fix fixing bolt of fan. Find out the reasons and adjust. Replace fan.
Heavy noise of compressor	Liquid slugging happens when liquid refrigerant enters into compressor. Internal parts in compressor are broken.	Check if expansion valve is failure and temp. sensor is loose. If that, repair it. Replace compressor.
Water pump does not run or runs abnormally	Malfunction of power supply or terminal. Malfunction of relay. There is air in water pipe.	Find out the reasons and repair. Replace relay. Evacuate.
Compressor starts or stops frequently	Poor or excess refrigerant. Poor circulation of water system. Low load.	Discharge or add part of refrigerant. Water system is blocked or there is air in it. Check water pump, valve and pipeline. Clean water filter or evacuate. Adjust the load or add accumulating devices.
The unit does not heat although compressor is running	Leakage of refrigerant. Malfunction of compressor.	Repair by leakage detection and add refrigerant. Replace compressor.

Malfunctions	Reasons	Troubleshooting
Poor efficiency of hot water heating	Poor heat insulation of water system. Poor heat exchange of evaporator. Poor refrigerant of unit. Blockage of heat exchanger at water side.	Enhance heat insulation efficiency of the system. Check if air in or out of unit is normal and clean evaporator of the unit. Check if refrigerant of unit leaks. Clean or replace heat exchanger.

#### 4.2 Notice before Seasonal Use

(1)Check whether air inlets and air outlets of indoor and outdoor units are blocked;

(2)Check whether ground connection is reliable or not;

(3)If unit starts up after not operating for a long time, it should be power on 8 hours before operation starts so as to preheat the outdoor compressor;

(4)Precautions for Freeze Protection in Winter

Under subzero climatic conditions in winter, anti-freeze fluid must be added into the water cycle and external water pipes should be properly insulated. Glycol solution is recommended as the anti-freeze fluid.

Concentration %	Freezing Temp °C	Concentration %	Freezing Temp °C	Concentration %	Freezing Temp °C
4.6	-2	19.8	-10	35	-21
8.4	-4	23.6	-13	38.8	-26
12.2	-5	27.4	-15	42.6	-29
16	-7	31.2	-17	46.4	-33

Note: "Concentration" listed in the table above indicates the mass concentration.

#### 4.3 Error Codes

No.	Full Name	Displayed Name	Error Code
1	Ambient temperature sensor error	Ambient sensor	F4
2	Defrosting temperature sensor error	Defrost sensor	d6
3	Discharge temperature sensor error	Discharge sensor	F7
4	Suction temperature sensor error	Suction sensor	F5
5	Economizer inlet temperature sensor	Econ. in sens.	F2
6	Economizer outlet temperature sensor	Econ. out sens.	F6
7	Fan error	Outdoor fan	EF
8	High pressure protection	High pressure	E1
9	Low pressure protection	Low pressure	E3
10	High discharge protection	Hi-discharge	E4
11	Capacity DIP switch error	Capacity DIP	c5
12	Communication error between the outdoor and indoor main boards	ODU-IDU Com.	E6
13	Communication error between the outdoor main board and the drive board	Drive-main com.	P6
14	Communication error between the display panel and indoor main board	IDU Com.	E6
15	High pressure sensor error	HI-pre. sens.	Fc
16	Leaving water temperature sensor error for the plate type heat exchanger of the heat pump	Temp-HELW	F9
17	Leaving water temperature sensor error for the auxiliary electric heat of the heat pump	Temp-AHLW	dH
18	Entering water temperature sensor error of the plate type heat exchanger of the heat pump	Temp-HEEW	No error code but displayed on control pannel
19	Water tank temperature sensor error ("NA" for mini chillers)	Tank sens.	FE
20	Remote room temperature sensor error	T-Remote Air	F3

## Air-to-water Heat Pump Split

No.	Full Name	Displayed Name	Error Code
21	Protection for the flow switch of the heat pump	HP-Water Switch	Ec
22	Welding protection to the auxiliary electric heater 1 of the heat pump	Auxi. heater 1	EH
23	Welding protection to the auxiliary electric heater 2 of the heat pump	Auxi. heater 2	EH
24	Welding protection to the water tank electric heater	Auxi. -WTH	EH
25	DC bus under-voltage or voltage drop error	DC under-vol.	PL
26	DC bus over-voltage	DC over-vol.	PH
27	AC current protection (input side)	AC curr. pro.	PA
28	IPM defective	IPM defective	H5
29	PFC defective	PFC defective	Hc
30	Start failure	Start failure	Lc
31	Phase loss	Phase loss	Ld
32	Jumper cap error	Jumper cap error	c5
33	Driver resetting	Driver reset	P0
34	Compressor overcurrent	Com. over-cur.	P5
35	Overspeed	Overspeed	LF
36	Current sensing circuit error or current sensor error	Current sen.	Pc
37	Desynchronization	Desynchronize	H7
38	Compressor stalling	Comp. stalling	LE
39	Radiator or IPM or PFC over-temperature	Overtemp.-mod.	P8
40	Radiator or IPM or PFC temperature sensor error	T-mod. sensor	P7
41	Charging circuit error	Charge circuit	Pu
42	AC input voltage error	AC voltage	PP
43	Ambient temperature sensor error at the drive board	Temp-driver	PF
44	AC contactor protection or input over-zero error	AC contactor	P9
45	Temperature drift protection	Temp. drift	PE
46	Sensor connection protection ( the current sensor fails to be connected with the corresponding phase U and or phase V)	Sensor con.	Pd
47	Communication error between the display panel and the outdoor unit	ODU Com.	E6
48	Refrigerant vapor line temperature sensor error	Temp RGL	F0
49	Refrigerant liquid line temperature sensor error	Temp RLL	F1
50	4-way valve error	4-way valve	U7



66139909575